



Product Manual

Barracuda 7200.8 PATA

ST3400832A

ST3300831A

ST3250823A

ST3200826A





Product Manual

Barracuda 7200.8 PATA

ST3400832A

ST3300831A

ST3250823A

ST3200826A



©2004, Seagate Technology LLC All rights reserved
Publication number: 100323825, Rev. B
November 2004

Seagate and Seagate Technology are registered trademarks of Seagate Technology LLC. SeaTools, SeaFONE, SeaBOARD, SeaTDD, and the Wave logo are either registered trademarks or trademarks of Seagate Technology LLC. Other product names are registered trademarks or trademarks of their owners.

Seagate reserves the right to change, without notice, product offerings or specifications. No part of this publication may be reproduced in any form without written permission of Seagate Technology LLC.

Revision status summary sheet

Revision	Date	Sheets Affected
Rev. A	10/08/04	Initial Release.
Rev. B	11/05/04	Updated DC power specifications. See page 7.

Contents

1.0	Introduction	1
2.0	Drive specifications	3
2.1	Specification summary table	3
2.2	Formatted capacity	5
2.2.1	LBA mode	5
2.3	Default logical geometry	5
2.4	Recording and interface technology	5
2.5	Physical characteristics	6
2.6	Seek time	6
2.7	Start/stop times	6
2.8	Power specifications	7
2.8.1	Power consumption	7
2.8.2	Conducted noise	8
2.8.3	Voltage tolerance	8
2.8.4	Power-management modes	9
2.9	Environmental specifications	10
2.9.1	Ambient temperature	10
2.9.2	Temperature gradient	10
2.9.3	Humidity	10
2.9.4	Altitude	10
2.9.5	Shock	11
2.9.6	Vibration	11
2.10	Acoustics	12
2.11	Electromagnetic immunity	12
2.12	Reliability	13
2.13	Agency certification	13
2.13.1	Safety certification	13
2.13.2	Electromagnetic compatibility	13
2.13.3	FCC verification	14
3.0	Configuring and mounting the drive	15
3.1	Handling and static discharge precautions	15
3.2	Breather filter hole precautions	16
3.3	Jumper settings	17
3.3.1	Master/slave configuration	17
3.3.2	Cable-select option	17
3.3.3	Alternate capacity jumper	17
3.3.4	Ultra ATA/100 cable	18
3.4	Drive mounting	18
4.0	ATA interface	21
4.1	ATA interface signals and connector pins	21
4.1.1	Supported ATA commands	22
4.1.2	Identify Device command	24
4.1.3	Set Features command	27
4.1.4	S.M.A.R.T. commands	27
5.0	Seagate Technology support services	29

List of Figures

Figure 1.	Typical 5V startup and operation current profile	8
Figure 2.	Typical 12V startup and operation current profile	8
Figure 3.	Breather filter hole location	16
Figure 4.	Master/slave jumper settings	17
Figure 5.	Ultra ATA cable connectors	18
Figure 6.	Mounting dimensions—top, side and end view	19
Figure 7.	I/O pins and supported ATA signals	21

1.0 Introduction

This manual describes the functional, mechanical and interface specifications for the following Seagate® Barracuda® 7200.8 PATA model drives:

Barracuda 7200.8 PATA

- ST3400832A
- ST3300831A
- ST3250823A
- ST3200826A

These drives provide the following key features:

- 7,200-RPM spindle speed
- 8-Mbyte buffer on: ST3400832A, ST3300831A, ST3250823A and ST3200826A.
- High instantaneous (burst) data transfer rates (up to 100 Mbytes per second) using Ultra DMA mode 5.
- Tunneling Giant magnetoresistive (TGMR) recording heads and EPRML technology, which provide the drives with increased areal density.
- State-of-the-art cache and on-the-fly error-correction algorithms.
- Full-track multiple-sector transfer capability without local processor intervention.
- Quiet operation.
- 300 Gs nonoperating shock.
- SeaTools diagnostic software performs a drive self-test that eliminates unnecessary drive returns.
- Support for S.M.A.R.T. drive monitoring and reporting.
- Support for Read Multiple and Write Multiple commands.
- Support for autodetection of master/slave drives that use cable select (CSEL).

2.0 Drive specifications

Unless otherwise noted, all specifications are measured under ambient conditions, at 25°C, and nominal power. For convenience, the phrases *the drive* and *this drive* are used throughout this manual to indicate ST3400832A, ST3300831A, ST3250823A and ST3200826A model drives.

2.1 Specification summary table

The specifications listed in this table are for quick reference. For details on specification measurement or definition, see the appropriate section of this manual.

Table 1: Drive specifications

Drive specification	ST3400832A	ST3300831A	ST3250823A	ST3200826A
Formatted Gbytes (512 bytes/sector)	400	300	250	200
Guaranteed sectors	781,422,768	586,072,368	488,397,168	390,721,968
Bytes per sector	512			
Default sectors per track	63			
Default read/write heads	16			
Default cylinders	16,383			
Recording density, BPI (bits/in max)	763,000			
Track density, TPI (tracks/in avg.)	120,000			
Areal density, (Mbits/in ² avg)	91,560			
Spindle speed (RPM)	7,200			
Internal data transfer rate (Mbytes/sec max)	95			
Sustained data transfer rate OD (Mbytes/sec)	65			
I/O data-transfer rate (Mbytes/sec max)	100			
ATA data-transfer modes supported	PIO modes 0–4 Multiword DMA modes 0–2 Ultra DMA modes 0–5			
Cache buffer	8 Mbytes (8,192 kbytes)			
Height (mm max)	26.11 mm (1.028 inches)			
Width (mm max)	101.85 mm (4.010 inches)			
Length (mm max)	146.99 mm (5.787 inches)			
Weight (max)	635 grams (1.39 lb.)			
Average latency (msec)	4.16			
Power-on to ready (sec max)	10.0 sec			
Standby to ready (sec max)	10.0 sec			
Track-to-track seek time (msec typical)	0.8 (read), 1.0 (write)			

Drive specification	ST3400832A	ST3300831A	ST3250823A	ST3200826A
Average seek, Performance mode (msec typical)	8.0 (read), 9.0 (write)			
Average seek, Quiet mode (msec typical)	11.0 (read), 12.0 (write)			
Startup current (typical) 12V (peak)	2.8 amps			
Seek power (typical)	12.4 watts			
Read/write power (typical)	12.8 watts			
Idle mode (typical)	7.2 watts			
Standby mode (typical)	0.8 watts			
Sleep mode (typical)	0.8 watts			
Voltage tolerance (including noise)	5V ± 5% 12V ± 10%			
Ambient temperature	0° to 60°C (operating) -40° to 70°C (nonoperating)			
Temperature gradient (°C per hour max)	20°C (operating) 30°C (nonoperating)			
Relative humidity	5% to 90% (operating) 5% to 95% (nonoperating)			
Relative humidity gradient	30% per hour max			
Wet bulb temperature (°C max)	37.7 (operating) 40 (nonoperating)			
Altitude, operating	-60.96 m to 3,048 m (-200 ft. to 10,000+ ft.)			
Altitude, nonoperating (below mean sea level, max)	-60.96 m to 12,192 m (-200 ft. to 40,000+ ft.)			
Operational Shock (Gs max at 2 msec)	63			
Non-Operational Shock (Gs max at 2 msec)	300 Gs			
Vibration, operating	0.25 G acceleration			
Vibration, nonoperating	0.25 G (5-22 Hz) 5.0 Gs (22-350 Hz)			
Drive acoustics, sound power				
Idle* (bels)	2.8 (typical) 3.4 (max)			
Quiet seek (bels)	3.2 (typical) 3.4 (max)			
Performance seek (bels)	3.7 (typical) 3.9 (max)			
Nonrecoverable read errors	1 per 10 ¹⁴ bits read			
Annualized Failure Rate (AFR)	0.34%			
Service life	5 Years			
Contact start-stop cycles (25°C, 50% rel. humidity)	50,000			

*During periods of drive idle, some offline activity may occur according to the S.M.A.R.T. specification, which may increase acoustic and power to operational levels.

2.2 Formatted capacity

Model	Formatted capacity	Guaranteed sectors	Bytes per sector
ST3400832A	400 Gbytes	781,422,768	512
ST3300831A	300 Gbytes	586,072,368	512
ST3250823A	250 Gbytes	488,397,168	512
ST3200826A	200 Gbytes	390,721,968	512

2.2.1 LBA mode

When addressing these drives in LBA mode, all blocks (sectors) are consecutively numbered from 0 to $n-1$, where n is the number of guaranteed sectors as defined above.

See Section 4.1.2, "Identify Device command" (words 60-61 and 100-103) for additional information about 48-bit addressing support of drives with capacities over 137 Gbytes.

2.3 Default logical geometry

Cylinders	Read/write heads	Sectors per track
16,383	16	63

2.4 Recording and interface technology

Interface	ATA
Recording method	16/17 EPRML
Recording density BPI (bits/inch max)	728,000
Track density TPI (tracks/inch avg)	120,000
Areal density (Mbits/inch ² avg)	91,560
Spindle speed (RPM) ($\pm 0.2\%$)	7,200
Internal data-transfer rate (Mbytes/sec max)	95
Sustained data transfer rate OD (Mbytes/sec max)	65.0
I/O data-transfer rate (Mbytes/sec max)	100 (Ultra DMA mode 5)
Interleave	1:1
Cache buffer ST3400832A, ST3300831A, ST3250823A and ST3200826A	8 Mbytes (8,192 kbytes)

2.5 Physical characteristics

Drive specification	
Maximum height (mm) (inches)	26.11 1.028
Maximum width (mm) (inches)	101.85 4.010
Maximum length (mm) (inches)	146.99 5.787
Max weight (grams) (pounds)	635 1.39

2.6 Seek time

Seek measurements are taken with nominal power at 25°C ambient temperature. All times are measured using drive diagnostics. The specifications in the table below are defined as follows:

- Track-to-track seek time is an average of all possible single-track seeks in both directions.
- Average seek time is a true statistical random average of at least 5,000 measurements of seeks between random tracks, less overhead.

Typical seek times (msec)	Read	Write
Track-to-track	0.8	1.0
Average	8.0	9.0
Average latency:	4.16	4.16

Note. These drives are designed to consistently meet the seek times represented in this manual. Physical seeks, regardless of mode (such as track-to-track and average), are expected to meet or exceed the noted values. However, due to the manner in which these drives are formatted, benchmark tests that include command overhead or measure logical seeks may produce results that vary from these specifications.

2.7 Start/stop times

Power-on to Ready (sec)	10 (max)
Standby to Ready (sec)	10 (max)
Ready to spindle stop (sec)	12 (max)

2.8 Power specifications

The drive receives DC power (+5V or +12V) through a four-pin standard drive power connector.

2.8.1 Power consumption

Power requirements for the drives are listed in the table on page 7. Typical power measurements are based on an average of drives tested, under nominal conditions, using +5.0V and +12.0V input voltage at 25°C ambient temperature.

- **Spinup power**

Spinup power is measured from the time of power-on to the time that the drive spindle reaches operating speed.

- **Seek mode**

During seek mode, the read/write actuator arm moves toward a specific position on the disc surface and does not execute a read or write operation. Servo electronics are active. Seek mode power represents the worst-case power consumption, using only random seeks with read or write latency time. This mode is not typical and is provided for worst-case information.

- **Read/write power and current**

Read/write power is measured with the heads on track, based on a 16-sector write followed by a 32-msec delay, then a 16-sector read followed by a 32-msec delay.

- **Operating power and current**

Operating power is measured using 40 percent random seeks, 40 percent read/write mode (1 write for each 10 reads) and 20 percent drive idle mode.

- **Idle mode power**

Idle mode power is measured with the drive up to speed, with servo electronics active and with the heads in a random track location.

- **Standby mode**

During Standby mode, the drive accepts commands, but the drive is not spinning, and the servo and read/write electronics are in power-down mode.

Table 2: DC power requirements

Power dissipation (watts) Example: ST3400832A	Average (watts, 25° C)	5V typ amps	12V typ amps
Spinup	—	—	2.8 (peak)
Idle	7.2	0.401	0.433
Idle* (with offline activity)	9.1	0.78	0.433
Operating (40% r/w, 40% seek, 20% inop.)	12.8	0.841	0.715
Seeking (random, 20% idle)	12.4	0.602	0.782
Standby	0.8	0.145	0.006
Sleep	0.8	0.145	0.006

*During periods of drive idle, some offline activity may occur according to the S.M.A.R.T. specification, which may increase acoustic and power to operational levels.

2.8.1.1 Typical current profile

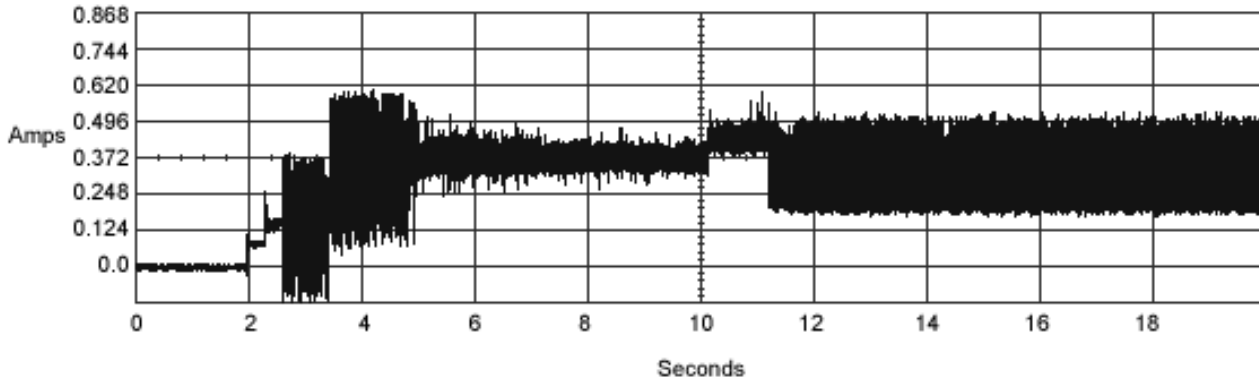

Figure 1 Typical 5V startup and operation current profile

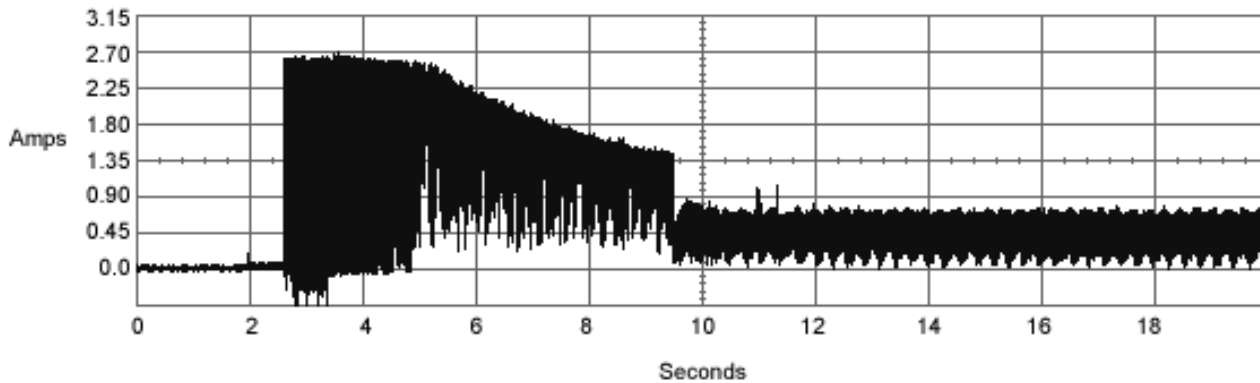

Figure 2 Typical 12V startup and operation current profile

2.8.2 Conducted noise

Input noise ripple is measured at the host system power supply across an equivalent 80-ohm resistive load on the +12 volt line or an equivalent 15-ohm resistive load on the +5 volt line.

- Using 12-volt power, the drive is expected to operate with a maximum of 120 mV peak-to-peak square-wave injected noise at up to 10 MHz.
- Using 5-volt power, the drive is expected to operate with a maximum of 100 mV peak-to-peak square-wave injected noise at up to 10 MHz.

Note. Equivalent resistance is calculated by dividing the nominal voltage by the typical RMS read/write current.

2.8.3 Voltage tolerance

Voltage tolerance (including noise):

- 5V \pm 5%
- 12V \pm 10%

2.8.4 Power-management modes

The drive provides programmable power management to provide greater energy efficiency. In most systems, you can control power management through the system setup program. The drive features the following power-management modes:

Power mode	Heads	Spindle	Buffer
Active	Tracking	Rotating	Enabled
Idle	Tracking	Rotating	Enabled
Standby	Parked	Stopped	Enabled
Sleep	Parked	Stopped	Disabled

- **Active mode**

The drive is in Active mode during the read/write and seek operations.

- **Idle mode**

The buffer remains enabled, and the drive accepts all commands and returns to Active mode any time disc access is necessary.

- **Standby mode**

The drive enters Standby mode when the host sends a Standby Immediate command. If the host has set the standby timer, the drive can also enter Standby mode automatically after the drive has been inactive for a specifiable length of time. The standby timer delay is established using a Standby or Idle command. In Standby mode, the drive buffer is enabled, the heads are parked and the spindle is at rest. The drive accepts all commands and returns to Active mode any time disc access is necessary.

- **Sleep mode**

The drive enters Sleep mode after receiving a Sleep command from the host. In Sleep mode, the drive buffer is disabled, the heads are parked and the spindle is at rest. The drive leaves Sleep mode after it receives a Hard Reset or Soft Reset from the host. After receiving a reset, the drive exits Sleep mode and enters Standby mode with all current translation parameters intact.

- **Idle and Standby timers**

Each time the drive performs an Active function (read, write or seek), the standby timer is reinitialized and begins counting down from its specified delay times to zero. If the standby timer reaches zero before any drive activity is required, the drive makes a transition to Standby mode. In both Idle and Standby mode, the drive accepts all commands and returns to Active mode when disc access is necessary.

2.9 Environmental specifications

2.9.1 Ambient temperature

Ambient temperature is defined as the temperature of the environment immediately surrounding the drive. Actual drive case temperature should not exceed 69°C (156°F) within the operating ambient conditions for standard models, or 64°C (147°F) within the operating ambient conditions for all models. Recommended measurement locations are shown in See Figure 6 on page 19.

Above 1,000 feet (305 meters), the maximum temperature is derated linearly to 112°F (44°C) at 10,000 feet (3,048 meters).

Operating:	0° to 60°C (32° to 140°F)
Nonoperating:	−40° to 70°C (−40° to 158°F)

2.9.2 Temperature gradient

Operating:	20°C per hour (68°F per hour max), without condensation
Nonoperating:	30°C per hour (86°F per hour max)

2.9.3 Humidity

2.9.3.1 Relative humidity

Operating:	5% to 90% noncondensing (30% per hour max)
Nonoperating:	5% to 95% noncondensing (30% per hour max)

2.9.3.2 Wet bulb temperature

Operating:	37.7°C (99.9°F max)
Nonoperating:	40°C (104°F max)

2.9.4 Altitude

Operating:	−60.96 m to 3,048 m (−200 ft. to 10,000+ ft.)
Nonoperating:	−60.96 m to 12,192 m (−200 ft. to 40,000+ ft.)

2.9.5 Shock

All shock specifications assume that the drive is mounted securely with the input shock applied at the drive mounting screws. Shock may be applied in the X, Y or Z axis.

2.9.5.1 Operating shock

These drives comply with the performance levels specified in this document when subjected to a maximum operating shock of 63 Gs based on half-sine shock pulses of 2 msec. Shocks should not be repeated more than two times per second.

2.9.5.2 Nonoperating shock

The nonoperating shock level that the drive can experience without incurring physical damage or degradation in performance when subsequently put into operation is 300 Gs based on a nonrepetitive half-sine shock pulse of 2 msec duration.

2.9.6 Vibration

All vibration specifications assume that the drive is mounted securely with the input vibration applied at the drive mounting screws. Vibration may be applied in the X, Y or Z axis.

2.9.6.1 Operating vibration

The following table lists the maximum vibration levels that the drive may experience while meeting the performance standards specified in this document.

5–350 Hz	0.25 G acceleration
----------	---------------------

2.9.6.2 Nonoperating vibration

The following table lists the maximum nonoperating vibration that the drive may experience without incurring physical damage or degradation in performance when subsequently put into operation.

5–22 Hz	0.25 G
22–350 Hz	5.0 Gs

2.10 Acoustics

Drive acoustics are measured as overall A-weighted acoustic sound power levels (no pure tones). All measurements are consistent with ISO document 7779. Sound power measurements are taken under essentially free-field conditions over a reflecting plane. For all tests, the drive is oriented with the cover facing upward.

Note. For seek mode tests, the drive is placed in seek mode only. The number of seeks per second is defined by the following equation:

$$(\text{Number of seeks per second} = 0.4 / (\text{average latency} + \text{average access time}))$$

Table 3: Fluid Dynamic Bearing (FDB) motor acoustics

Acoustic mode		
Idle*	Quiet seek	Performance seek
2.8 bels (typ) 3.4 bels (max)	3.2 bels (typ) 3.4 bels (max)	3.7 bels (typ) 3.9 bels (max)

*During periods of drive idle, some offline activity may occur according to the S.M.A.R.T. specification, which may increase acoustic and power to operational levels.

2.11 Electromagnetic immunity

When properly installed in a representative host system, the drive operates without errors or degradation in performance when subjected to the radio frequency (RF) environments defined in the following table:

Table 4: Radio frequency environments

Test	Description	Performance level	Reference standard
Electrostatic discharge	Contact, HCP, VCP: ± 4 kV; Air: ± 8 kV	B	EN 61000-4-2: 95
Radiated RF immunity	80 to 1,000 MHz, 3 V/m, 80% AM with 1 kHz sine 900 MHz, 3 V/m, 50% pulse modulation @ 200 Hz	A	EN 61000-4-3: 96 ENV 50204: 95
Electrical fast transient	± 1 kV on AC mains, ± 0.5 kV on external I/O	B	EN 61000-4-4: 95
Surge immunity	± 1 kV differential, ± 2 kV common, AC mains	B	EN 61000-4-5: 95
Conducted RF immunity	150 kHz to 80 MHz, 3 Vrms, 80% AM with 1 kHz sine	A	EN 61000-4-6: 97
Voltage dips, interrupts	0% open, 5 seconds 0% short, 5 seconds 40%, 0.10 seconds 70%, 0.01 seconds	C C C B	EN 61000-4-11: 94

2.12 Reliability

Nonrecoverable read errors	1 per 10 ¹⁴ bits read, max.
Annualized Failure Rate (AFR)	0.34% (nominal power, 25°C ambient temperature)
Contact start-stop cycles	50,000 cycles (at nominal voltage and temperature, with 60 cycles per hour and a 50% duty cycle)
Service Life	5 Years
Preventive maintenance	None required

2.13 Agency certification

2.13.1 Safety certification

The drives are recognized in accordance with UL 1950 and CSA C22.2 (950) and meet all applicable sections of IEC950 and EN 60950 as tested by TUV North America.

2.13.2 Electromagnetic compatibility

Hard drives that display the CE mark comply with the European Union (EU) requirements specified in the Electromagnetic Compatibility Directive (89/336/EEC). Testing is performed to the levels specified by the product standards for Information Technology Equipment (ITE). Emission levels are defined by EN 55022, Class B and the immunity levels are defined by EN 55024.

Seagate uses an independent laboratory to confirm compliance with the EC directives specified in the previous paragraph. Drives are tested in representative end-user systems. Although CE-marked Seagate drives comply with the directives when used in the test systems, we cannot guarantee that all systems will comply with the directives. The drive is designed for operation inside a properly designed enclosure, with properly shielded I/O cable (if necessary) and terminators on all unused I/O ports. Computer manufacturers and system integrators should confirm EMC compliance and provide CE marking for their products.

Korean RRL

If these drives have the Korea Ministry of Information and Communication (MIC) logo, they comply with paragraph 1 of Article 11 of the Electromagnetic Compatibility control Regulation and meet the Electromagnetic Compatibility (EMC) Framework requirements of the Radio Research Laboratory (RRL) Ministry of Information and Communication Republic of Korea.

These drives have been tested and comply with the Electromagnetic Interference/Electromagnetic Susceptibility (EMI/EMS) for Class B products. Drives are tested in a representative, end-user system by a Korean-recognized lab.

- EUT name (model numbers): ST3400832A, ST3300831A, ST3250823A and ST3200826A.
- Certificate numbers:

ST3400832A	E-H0xx-0x-xxxx (pending)
ST3300831A	E-H0xx-0x-xxxx (pending)
ST3250823A	E-H0xx-0x-xxxx (pending)
ST3200826A	E-H0xx-0x-xxxx (pending)
- Trade name or applicant: Seagate Technology
- Manufacturing date: November 2004
- Manufacturer/nationality: Singapore and China

Australian C-Tick (N176)

If these models have the C-Tick marking, they comply with the Australia/New Zealand Standard AS/NZS3548 1995 and meet the Electromagnetic Compatibility (EMC) Framework requirements of the Australian Communication Authority (ACA).

2.13.3 FCC verification

These drives are intended to be contained solely within a personal computer or similar enclosure (not attached as an external device). As such, each drive is considered to be a subassembly even when it is individually marketed to the customer. As a subassembly, no Federal Communications Commission verification or certification of the device is required.

Seagate Technology LLC has tested this device in enclosures as described above to ensure that the total assembly (enclosure, disc drive, motherboard, power supply, etc.) does comply with the limits for a Class B computing device, pursuant to Subpart J, Part 15 of the FCC rules. Operation with noncertified assemblies is likely to result in interference to radio and television reception.

Radio and television interference. This equipment generates and uses radio frequency energy and if not installed and used in strict accordance with the manufacturer's instructions, may cause interference to radio and television reception.

This equipment is designed to provide reasonable protection against such interference in a residential installation. However, there is no guarantee that interference will not occur in a particular installation. If this equipment does cause interference to radio or television, which can be determined by turning the equipment on and off, you are encouraged to try one or more of the following corrective measures:

- Reorient the receiving antenna.
- Move the device to one side or the other of the radio or TV.
- Move the device farther away from the radio or TV.
- Plug the computer into a different outlet so that the receiver and computer are on different branch outlets.

If necessary, you should consult your dealer or an experienced radio/television technician for additional suggestions. You may find helpful the following booklet prepared by the Federal Communications Commission: *How to Identify and Resolve Radio-Television Interference Problems*. This booklet is available from the Superintendent of Documents, U.S. Government Printing Office, Washington, DC 20402. Refer to publication number 004-000-00345-4.

3.0 Configuring and mounting the drive

This section contains the specifications and instructions for configuring and mounting the drive.

3.1 Handling and static discharge precautions

After unpacking, and before installation, the drive may be exposed to potential handling and electrostatic discharge (ESD) hazards. Observe the following standard handling and static-discharge precautions:

Caution:

- Before handling the drive, put on a grounded wrist strap, or ground yourself frequently by touching the metal chassis of a computer that is plugged into a grounded outlet. Wear a grounded wrist strap throughout the entire installation procedure.
- Handle the drive by its edges or frame *only*.
- The drive is extremely fragile—handle it with care. Do not press down on the drive top cover.
- Always rest the drive on a padded, antistatic surface until you mount it in the computer.
- Do not touch the connector pins or the printed circuit board.
- Do not remove the factory-installed labels from the drive or cover them with additional labels. Removal voids the warranty. Some factory-installed labels contain information needed to service the drive. Other labels are used to seal out dirt and contamination.

3.2 Breather filter hole precautions

This section contains information regarding the precautions which should be taken regarding the breather filter hole in Seagate hard disc drives. Proper precautions should be taken to ensure full functionality and prevent possible damage to the drive.

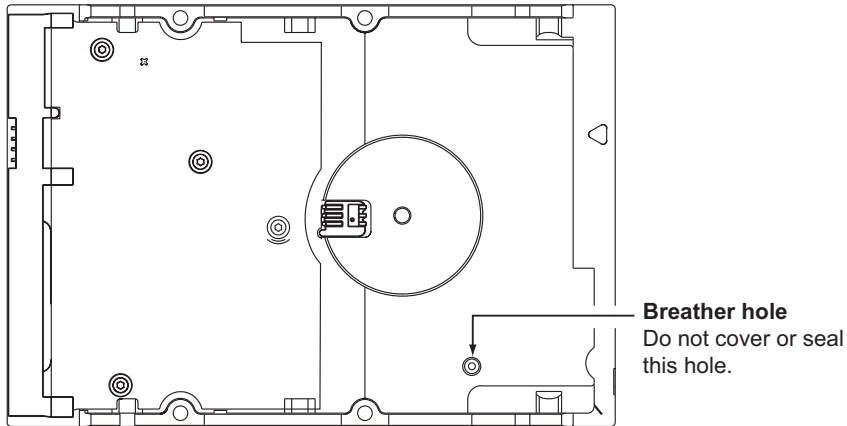

Figure 3 Breather filter hole location

Caution: Do not cover, seal, or insert any object into this hole.

This hole has two purposes:

- To allow condensation inside the hard disc to escape
- To allow air pressure inside the hard disc to equalize with ambient pressure

Note. If this hole is covered, sealed, or penetrated by any object, the drive reliability may be compromised and could lead to permanent damage. Covering or sealing this hole voids the warranty.

3.3 Jumper settings

3.3.1 Master/slave configuration

The options jumper block shown in Figure 4 is used to configure the drive for operation. It is the 8-pin dual header between the interface connector and the power connector. Use the following settings to configure the drive as a master or a slave.

Master or single drive. The drive is configured at the factory for a master or single-drive operation with a jumper set on pins 7 and 8.

Drive as slave. Remove all jumpers.

Drive as master with a non-ATA-compatible slave.

Use this jumper setting *only* if the drive does not work as a master with no jumpers installed.

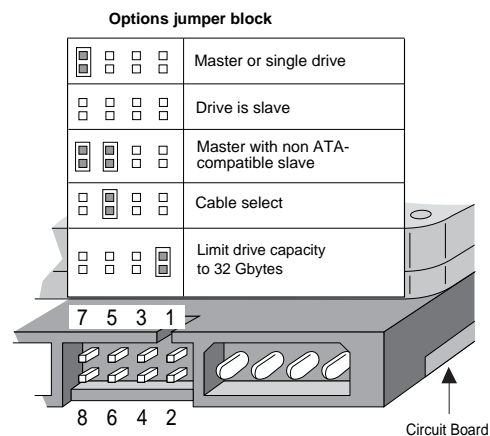

Figure 4 Master/slave jumper settings

3.3.2 Cable-select option

Computers that use cable select determine the master and slave drives by selecting or deselecting pin 28, CSEL, on the interface bus. Master and slave drives are determined by their physical position on the cable. To enable cable select, set a jumper on pins 5 and 6 as shown in Figure 4. Refer to your computer manual to determine whether your computer supports this option.

3.3.3 Alternate capacity jumper

Some older computers may “hang” at startup if their BIOS detects a disc drive with a capacity greater than 32 Gbytes. This limits the drive’s capacity to 32 Gbytes when the alternate capacity jumper is used. To access the full capacity of the drive, you can:

- Update the BIOS
- Use third-party software such as DiscWizard™ or Disk Manager
- Use a third-party host adapter

For drives with capacities greater than 32 Gbytes, the alternate capacity jumper changes the total available LBA sectors to 32 Gbytes to solve issues with some BIOS during power on. The ATA Set Features subcommand “F1_H Report Full Capacity Available” causes Identify Data words 60 and 61 to report the full capacity. See Section 4.1.3 on page 27 for more details on the Set Features command.

Windows XP, Windows Me, Windows 98 or newer versions are needed to support drives with capacities greater than 32 Gbytes.

3.3.4 Ultra ATA/100 cable

An 80-conductor 40-pin cable is required to run Ultra DMA mode 3, mode 4, and mode 5. This cable uses even-numbered conductors connected to the ground pins to improve signal integrity.

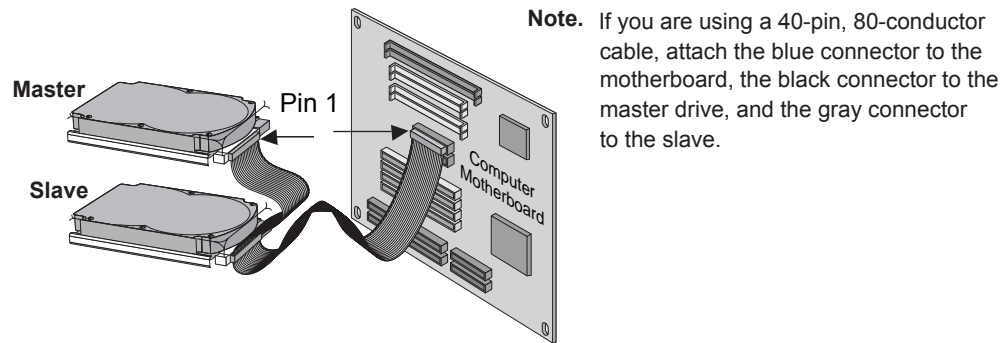

Figure 5 Ultra ATA cable connectors

Note. The drive supports both host and drive cable detection. The host detects the 80-conductor cable by sampling pin 34, CBLID $_{-}$, on the interface bus. The drive detects the 80-conductor cable by sensing a capacitor at the host side through the CBLID $_{-}$ signal. The result is reported in a Fast Rise Detected bit (bit 13 of word 93 in the Identify drive parameter block).

3.4 Drive mounting

You can mount the drive in any orientation using four screws in the side-mounting holes or four screws in the bottom-mounting holes. See Figure 6 for drive mounting dimensions. Follow these important mounting precautions when mounting the drive:

- Allow a minimum clearance of 0.030 inches (0.76 mm) around the entire perimeter of the drive for cooling.
- Use only 6-32 UNC mounting screws.
- Do not overtighten the mounting screws (maximum torque: 6 inch-lb.).
- Do not use a drive interface cable that is more than 18 inches long.

Notes:

1. Dimensions are shown in inches (mm).
2. Dimensions per SFF-8301 specification.

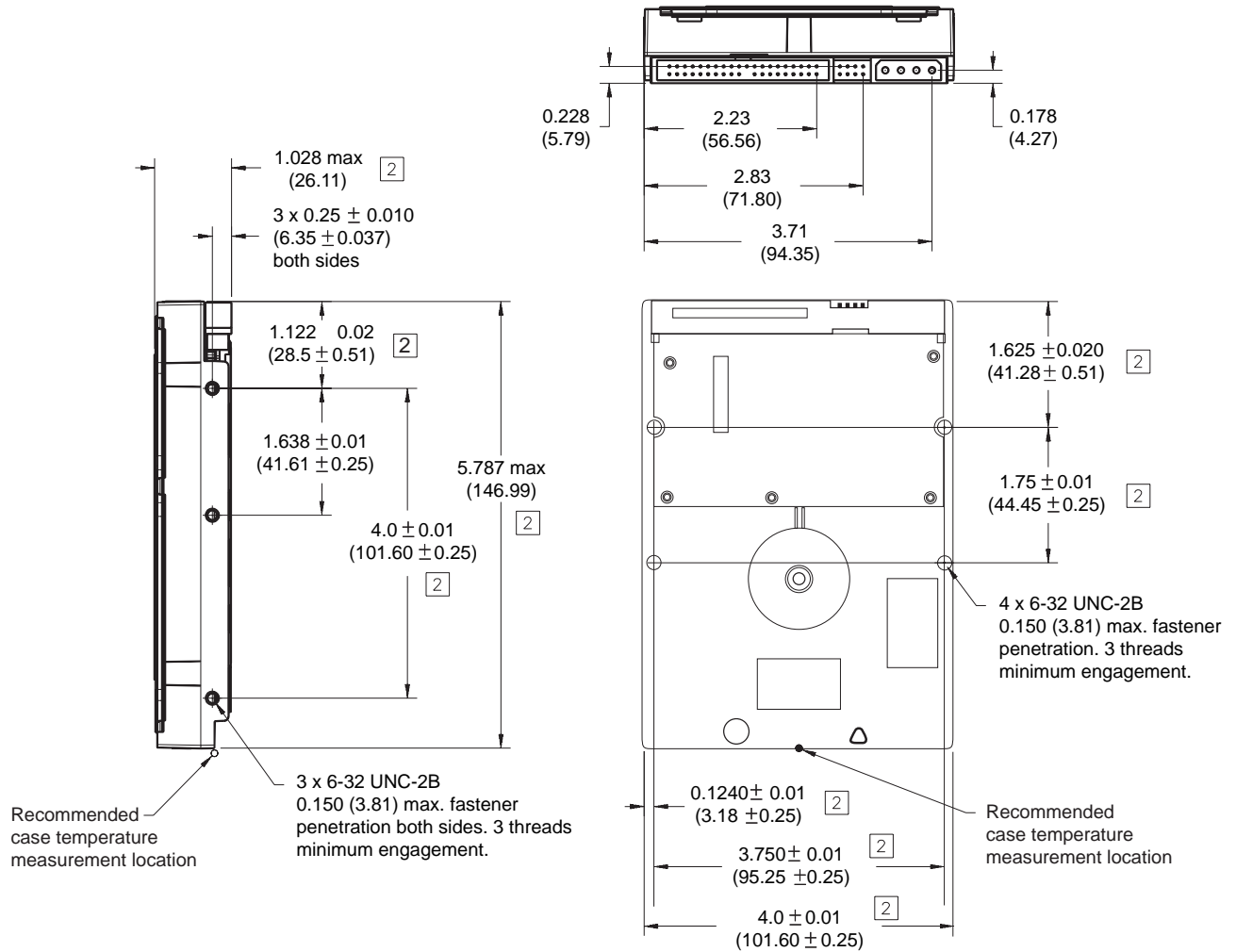

Figure 6 Mounting dimensions—top, side and end view

4.0 ATA interface

These drives use the industry-standard ATA task file interface that supports 16-bit data transfers. It supports ATA programmed input/output (PIO) modes 0–4; multiword DMA modes 0–2, and Ultra DMA modes 0–5. The drive also supports the use of the IORDY signal to provide reliable high-speed data transfers.

You can use a daisy-chain cable to connect two drives to a single AT host bus. For detailed information about the ATA interface, refer to the draft of *AT Attachment with Packet Interface Extension (ATA/ATAPI-7)*, *NCITS T13 1410D*, subsequently referred to as the *Draft ATA-7 Standard*.

4.1 ATA interface signals and connector pins

Figure 7 on page 21 summarizes the signals on the ATA interface connector that the drive supports. For a detailed description of these signals, refer to the *Draft ATA-7 Standard*.

Drive pin #	Signal name	Host pin # and signal description
1	Reset-	1 Hardware Reset
2	Ground	2 Ground
3	DD7	3 Host Data Bus Bit 7
4	DD8	4 Host Data Bus Bit 8
5	DD6	5 Host Data Bus Bit 6
6	DD9	6 Host Data Bus Bit 9
7	DD5	7 Host Data Bus Bit 5
8	DD10	8 Host Data Bus Bit 10
9	DD4	9 Host Data Bus Bit 4
10	DD11	10 Host Data Bus Bit 11
11	DD3	11 Host Data Bus Bit 3
12	DD12	12 Host Data Bus Bit 12
13	DD2	13 Host Data Bus Bit 2
14	DD13	14 Host Data Bus Bit 13
15	DD1	15 Host Data Bus Bit 1
16	DD14	16 Host Data Bus Bit 14
17	DD0	17 Host Data Bus Bit 0
18	DD15	18 Device Data (15:0)
19	Ground	19 Ground
20	(removed)	20 (No Pin)
21	DMARQ	21 DMA Request
22	Ground	22 Ground
23	DIOW-	23 Device I/O Write: Stop Ultra DMA Burst
24	Ground	24 Ground
25	DIOR-	25 Device I/O Read: Host Ultra DMA Ready: Host Ultra DMA Data Strobe
26	Ground	26 Ground
27	IORDY	27 I/O Channel Ready Device Ultra DMA Ready Device Ultra DMA Data Strobe
28	CSEL	28 Cable Select
29	DMACK-	29 DMA Acknowledge
30	Ground	30 Ground
31	INTRQ	31 Device Interrupt
32	IOCS16-	32 Reserved
33	DA1	33 Host Address Bus Bit 1
34	PDIAG-	34 Passed Diagnostics
	CBLID-	Cable Assembly Type Identifier
35	DA0	35 Device Address (2:0)
36	DA2	36 Device Address (2:0)
37	CS0-	37 Chip Select (1:0)
38	CS1-	38 Chip Select (1:0)
39	DASP-	39 Drive Active/Slave Present
40	Ground	40 Ground

Pins 28, 34 and 39 are used for master-slave communication (details shown below).

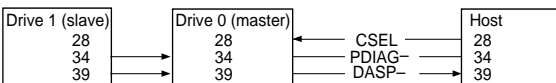

Figure 7 I/O pins and supported ATA signals

4.1.1 Supported ATA commands

The following table lists ATA-standard commands that the drive supports. For a detailed description of the ATA commands, refer to the *Draft ATA-7 Standard*. See “S.M.A.R.T. commands” on page 27 for details and sub-commands used in the S.M.A.R.T. implementation.

Table 5: Supported ATA commands

Command name	Command code (in hex)
Check Power Mode	98 _H or E5 _H
Device Configuration Freeze Lock	B1 _H / C1 _H
Device Configuration Identify	B1 _H / C2 _H
Device Configuration Restore	B1 _H / C0 _H
Device Configuration Set	B1 _H / C3 _H
Device Reset	08 _H
Download Microcode	92 _H
Execute Device Diagnostics	90 _H
Flush Cache	E7 _H
Flush Cache Extended	EA _H
Format Track	50 _H
Identify Device	EC _H
Idle	97 _H or E3 _H
Idle Immediate	95 _H or E1 _H
Initialize Device Parameters	91 _H
Read Buffer	E4 _H
Read DMA	C8 _H
Read DMA Extended	25 _H
Read DMA Without Retries	C9 _H
Read Log Ext	2F _H
Read Multiple	C4 _H
Read Multiple Extended	29 _H
Read Native Max Address	F8 _H
Read Native Max Address Extended	27 _H
Read Sectors	20 _H
Read Sectors Extended	24 _H
Read Sectors Without Retries	21 _H
Read Verify Sectors	40 _H
Read Verify Sectors Extended	42 _H
Read Verify Sectors Without Retries	41 _H
Recalibrate	10 _H
Security Disable Password	F6 _H
Security Erase Prepare	F3 _H

Command name	Command code (in hex)
Security Erase Unit	F4 _H
Security Freeze	F5 _H
Security Set Password	F1 _H
Security Unlock	F2 _H
Seek	70 _H
Set Features	EF _H
Set Max Address Note: Individual Set Max Address commands are identified by the value placed in the Set Max Features register as defined to the right.	F9 _H Address: 00 _H Password: 01 _H Lock: 02 _H Unlock: 03 _H Freeze Lock: 04 _H
Set Max Address Extended	37 _H
Set Multiple Mode	C6 _H
Sleep	99 _H or E6 _H
S.M.A.R.T. Disable Operations	B0 _H / D9 _H
S.M.A.R.T. Enable/Disable Autosave	B0 _H / D2 _H
S.M.A.R.T. Enable Operations	B0 _H / D8 _H
S.M.A.R.T. Execute Offline	B0 _H / D4 _H
S.M.A.R.T. Read Attribute Thresholds	B0 _H / D1 _H
S.M.A.R.T. Read Data	B0 _H / D0 _H
S.M.A.R.T. Read Log Sector	B0 _H / D5 _H
S.M.A.R.T. Return Status	B0 _H / DA _H
S.M.A.R.T. Save Attribute Values	B0 _H / D3 _H
S.M.A.R.T. Write Log Sector	B0 _H / D6 _H
Standby	96 _H or E2 _H
Standby Immediate	94 _H or E0 _H
Write Buffer	E8 _H
Write DMA	CA _H
Write DMA Extended	35 _H
Write DMA Without Retries	CB _H
Write Log Extended	3F _H
Write Multiple	C5 _H
Write Multiple Extended	39 _H
Write Sectors	30 _H
Write Sectors Without Retries	31 _H
Write Sectors Extended	34 _H

4.1.2 Identify Device command

The Identify Device command (command code EC_H) transfers information about the drive to the host following power up. The data is organized as a single 512-byte block of data, whose contents are shown in the Table 5 on page 22. All reserved bits or words should be set to zero. Parameters listed with an “x” are drive-specific or vary with the state of the drive. See Section 2.0 on page 3 for default parameter settings.

The following commands contain drive-specific features that may not be included in the *Draft ATA-7 Standard*.

Word	Description	Value
0	Configuration information: • Bit 15: 0 = ATA; 1 = ATAPI • Bit 7: removable media • Bit 6: removable controller • Bit 0: reserved	0C5A _H
1	Number of logical cylinders	16,383
2	ATA-reserved	0000 _H
3	Number of logical heads	16
4	Retired	0000 _H
5	Retired	0000 _H
6	Number of logical sectors per logical track: 63	003F _H
7–9	Retired	0000 _H
10–19	Serial number: (20 ASCII characters, 0000 _H = none)	ASCII
20	Retired	0000 _H
21	Retired	0400 _H
22	Obsolete	0000 _H
23–26	Firmware revision (8 ASCII character string, padded with blanks to end of string)	x.xx
27–46	Drive model number (40 ASCII characters, padded with blanks to end of string)	ST3400832A ST3300831A ST3250823A ST3200826A
47	(Bits 7–0) Maximum sectors per interrupt on Read multiple and Write multiple (16)	8010 _H
48	Reserved	0000 _H
49	Standard Standby timer, IORDY supported and may be disabled	2F00 _H
50	ATA-reserved	0000 _H
51	PIO data-transfer cycle timing mode	0200 _H
52	Retired	0200 _H
53	Words 54–58, 64–70 and 88 are valid	0007 _H
54	Number of current logical cylinders	xxxx _H
55	Number of current logical heads	xxxx _H
56	Number of current logical sectors per logical track	xxxx _H
57–58	Current capacity in sectors	xxxx _H
59	Number of sectors transferred during a Read Multiple or Write Multiple command	xxxx _H

Word	Description	Value
60–61	Total number of user-addressable LBA sectors available (see Section 2.2 for related information) *Note: The maximum value allowed in this field is: 0FFFFFFFh (268,435,455 sectors, 137 Gbytes). Drives with capacities over 137 Gbytes will have 0FFFFFFFh in this field and the actual number of user-addressable LBAs specified in words 100-103. This is required for drives that support the 48-bit addressing feature.	ST3400832A = 0FFFFFFFh* ST3300831A = 0FFFFFFFh* ST3250823A = 0FFFFFFFh* ST3200826A = 0FFFFFFFh*
62	Retired	0000 _H
63	Multiword DMA active and modes supported (see note following this table)	xx07 _H
64	Advanced PIO modes supported (modes 3 and 4 supported)	0003 _H
65	Minimum multiword DMA transfer cycle time per word (120 nsec)	0078 _H
66	Recommended multiword DMA transfer cycle time per word (120 nsec)	0078 _H
67	Minimum PIO cycle time without IORDY flow control (240 nsec)	00F0 _H
68	Minimum PIO cycle time with IORDY flow control (120 nsec)	0078 _H
69–74	ATA-reserved	0000 _H
75	Queue depth	0000 _H
76–79	SATA-specific	xxxx _H
80	Major version number	007E _H
81	Minor version number	0000 _H
82	Command sets supported	346B _H
83	Command sets supported	7D01 _H
84	Command sets support extension	4003 _H
85	Command sets enabled	34xx _H
86	Command sets enabled	3xxx _H
87	Command sets enable extension	4003 _H
88	Ultra DMA support and current mode (see note following this table)	xx3F _H
89	Security erase time	0000 _H
90	Enhanced security erase time	0000 _H
92	Master password revision code	FFFE _H
93	Hardware reset value (see description following this table)	xxxx _H
95–99	ATA-reserved	0000 _H
100–103	Total number of user-addressable LBA sectors available (see Section 2.2 for related information). These words are required for drives that support the 48-bit addressing feature. Maximum value: 0000FFFFFFFFFh.	ST3400832A = 781,422,768 ST3300831A = 586,072,368 ST3250823A = 488,397,168 ST3200826A = 390,721,968
104–127	ATA-reserved	0000 _H
128	Security status	0001 _H
129–159	Seagate-reserved	xxxx _H
160–254	ATA-reserved	0000 _H
255	Integrity word	xxA5 _H

Note. Advanced Power Management (APM) and Automatic Acoustic Management (AAM) features are not supported

Note. See the bit descriptions below for words 63, 88, and 93 of the Identify Drive data:

Description (if bit is set to 1)		
	Bit	Word 63
	0	Multiword DMA mode 0 is supported.
	1	Multiword DMA mode 1 is supported.
	2	Multiword DMA mode 2 is supported.
	8	Multiword DMA mode 0 is currently active.
	9	Multiword DMA mode 1 is currently active.
	10	Multiword DMA mode 2 is currently active.
	Bit	Word 88
	0	Ultra DMA mode 0 is supported.
	1	Ultra DMA mode 1 is supported.
	2	Ultra DMA mode 2 is supported.
	3	Ultra DMA mode 3 is supported.
	4	Ultra DMA mode 4 is supported.
	5	Ultra DMA mode 5 is supported.
	8	Ultra DMA mode 0 is currently active.
	9	Ultra DMA mode 1 is currently active.
	10	Ultra DMA mode 2 is currently active.
	11	Ultra DMA mode 3 is currently active.
	12	Ultra DMA mode 4 is currently active.
	13	Ultra DMA mode 5 is currently active.
	Bit	Word 93
	13	1 = 80-conductor cable detected, CBLID above V_{IH} 0 = 40-conductor cable detected, CBLID below V_{IL}

4.1.3 Set Features command

This command controls the implementation of various features that the drive supports. When the drive receives this command, it sets BSY, checks the contents of the Features register, clears BSY and generates an interrupt. If the value in the register does not represent a feature that the drive supports, the command is aborted. Power-on default has the read look-ahead and write caching features enabled. The acceptable values for the Features register are defined as follows:

02 _H	Enable write cache (<i>default</i>).
03 _H	Set transfer mode (based on value in Sector Count register). Sector Count register values:
00 _H	Set PIO mode to default (PIO mode 2).
01 _H	Set PIO mode to default and disable IORDY (PIO mode 2).
08 _H	PIO mode 0
09 _H	PIO mode 1
0A _H	PIO mode 2
0B _H	PIO mode 3
0C _H	PIO mode 4 (<i>default</i>)
20 _H	Multiword DMA mode 0
21 _H	Multiword DMA mode 1
22 _H	Multiword DMA mode 2
40 _H	Ultra DMA mode 0
41 _H	Ultra DMA mode 1
42 _H	Ultra DMA mode 2
43 _H	Ultra DMA mode 3
44 _H	Ultra DMA mode 4
45 _H	Ultra DMA mode 5
55 _H	Disable read look-ahead (read cache) feature.
82 _H	Disable write cache.
AA _H	Enable read look-ahead (read cache) feature (<i>default</i>).
F1 _H	Report full capacity available

Note. At power-on, or after a hardware or software reset, the default values of the features are as indicated above.

4.1.4 S.M.A.R.T. commands

S.M.A.R.T. provides near-term failure prediction for disc drives. When S.M.A.R.T. is enabled, the drive monitors predetermined drive attributes that are susceptible to degradation over time. If self-monitoring determines that a failure is likely, S.M.A.R.T. makes a status report available to the host. Not all failures are predictable. S.M.A.R.T. predictability is limited to the attributes the drive can monitor. For more information on S.M.A.R.T. commands and implementation, see the *Draft ATA-7 Standard*.

SeaTools diagnostic software activates a built-in drive self-test (DST S.M.A.R.T. command for D4_H) that eliminates unnecessary drive returns. The diagnostic software ships with all new drives and is also available at: <http://seatools.seagate.com>.

This drive is shipped with S.M.A.R.T. features disabled. You must have a recent BIOS or software package that supports S.M.A.R.T. to enable this feature. The table below shows the S.M.A.R.T. command codes that the drive uses.

Code in features register	S.M.A.R.T. command
D0 _H	S.M.A.R.T. Read Data
D2 _H	S.M.A.R.T. Enable/Disable Attribute Autosave
D3 _H	S.M.A.R.T. Save Attribute Values
D4 _H	S.M.A.R.T. Execute Off-line Immediate (runs DST)
D5 _H	S.M.A.R.T. Read Log Sector
D6 _H	S.M.A.R.T. Write Log Sector
D8 _H	S.M.A.R.T. Enable Operations
D9 _H	S.M.A.R.T. Disable Operations
DA _H	S.M.A.R.T. Return Status

Note. If an appropriate code is not written to the Features Register, the command is aborted and 0x04 (abort) is written to the Error register.

5.0 Seagate Technology support services

Online Services

Internet

www.seagate.com for information about Seagate products and services. Worldwide support is available 24 hours daily by e-mail for your questions.

Presales Support: www.seagate.com/support/email/email_presales.html or DiscPresales@Seagate.com

Technical Support: www.seagate.com/support/email/email_disc_support.html or DiscSupport@Seagate.com

mySeagate

my.seagate.com is the industry's first Web portal designed specifically for OEMs and distributors. It provides self-service access to critical applications, personalized content and the tools that allow our partners to manage their Seagate account functions. Submit pricing requests, orders and returns through a single, password-protected Web interface—anytime, anywhere in the world.

For support, questions and comments:

E-mail: partner.support@seagate.com

Phone (direct): +1-405-324-4740

Phone (toll-free): 1-877-347-2444 (US and Canada), or access a complete list of region-specific international toll-free phone numbers at my.seagate.com

reseller.seagate.com

reseller.seagate.com supports Seagate resellers with product information, program benefits and sales tools. You may register for customized communications that are not available on the web. These communications contain product launch, EOL, pricing, promotions and other channel-related information. To learn more about the benefits or to register, go to reseller.seagate.com, any time, from anywhere in the world.

reseller.seagate.com partner support

24 hours a day, seven days a week:

By web form: reseller.seagate.com/contact/forms

By phone: Access a complete list of regional phone numbers at reseller.seagate.com/support/

Seagate Online Store

US customers can purchase Seagate disc drives 24 hours daily at www.seagate.com/buy/online/.

Automated Phone Services

SeaFONE® (1-800-SEAGATE) is the Seagate toll-free number (1-800-732-4283) to access our automated self-help and directory assistance for Seagate support services. Using a touch-tone phone, you can find service and support phone numbers, answers to commonly asked questions, troubleshooting tips and specifications for disc drives 24 hours daily. International callers can reach this service by dialing +1-405-324-4770.

Presales, Technical Support and Customer Service

Presales Support

Our Presales Support staff can help you determine which Seagate products are best suited for your specific application or computer system.

Technical Support

If you need help installing your drive, consult your system's documentation or contact the dealer's support services department for assistance specific to your system. Seagate technical support is also available to assist you online at support.seagate.com or through one of our technical support service centers. Have your system configuration information and your drive's "ST" model number available.

SeaTDD™ (+1-405-324-3655) is a telecommunications device for the deaf (TDD). You can send questions or comments 24 hours daily and exchange messages with a technical support specialist during normal business hours for the technical support call center in your region.

Warranty Service

Seagate offers worldwide customer support for Seagate drives. Seagate distributors, OEMs and other direct customers should contact their Seagate service center representative for warranty-related issues. Resellers or end users of drive products should contact their place of purchase or one of the Seagate warranty service centers for assistance. Have your drive's "ST" model number and serial number available.

Authorized Service Centers

In some countries outside the US, you can contact an Authorized Service Center for service.

USA/Canada/Latin America Support Services

Presales Support

Call Center	Toll-free	Direct dial	FAX
Americas	1-877-271-3285 ¹	+1-405-324-4730 ¹	+1-405-324-4704

Technical Support

Call Center	Toll-free	Direct dial	FAX
Americas	1-800-SEAGATE ²	+1-405-324-4700 ³	+1-405-324-4702

Warranty Service

Call Center	Toll-free	Direct dial	FAX / Internet
USA, Mexico and Latin America	1-800-468-3472 ⁴	+1-405-324-4720 ⁴	+1-405-324-4722
Canada <i>Memofix</i> ⁵	1-800-636-6349	+1-905-660-4936	+1-905-660-4951 www.memofix.com
Brazil <i>MA Centro de Serviços</i> ⁵	—	+55-21-2509-7267 www.mainformatica.com.br/produtos.htm	+55-21-2507-6672

¹Hours of operation are 8:00 A.M. to 11:45 A.M. and 1:00 P.M. to 6:00 P.M., Monday through Friday (Central time)

²For product-specific phone number

³Hours of operation are 8:00 A.M. to 8:00 P.M., Monday through Friday (Central time)

⁴Hours of operation are 8:30 A.M. to 12:15 P.M. and 1:30 P.M. to 5:30 P.M., Monday through Friday (Central time)

⁵Authorized Service Center

European Support Services

For presales and technical support in Europe, dial the toll-free number for your specific country. If your country is not listed here, dial our presales and technical support call center at +1-405-324-4714 from 8:00 A.M. to 11:45 A.M. and 1:00 P.M. to 5:00 P.M. (Central Europe time) Monday through Friday. The presales and technical support call center is located in Oklahoma City, USA.

For European warranty service, dial the toll-free number for your specific country. If your country is not listed here, dial our European call center at +31-20-316-7222 from 8:30 A.M. to 5:00 P.M. (Central Europe time) Monday through Friday. The warranty service call center is located in Amsterdam, The Netherlands.

Toll-Free Support Numbers

Call Center	Presales and Technical Support	Warranty Service
Austria	0 800-20 12 90	0 800-20 12 90
Belgium	00 800-47324283 (00 800-4SEAGATE)	00 800-47324289
Denmark	00 800-47324283	00 800-47324289
France	00 800-47324283	00 800-47324289
Germany	00 800-47324283	00 800-47324289
Ireland	00 800-47324283	00 800-47324289
Italy	00 800-47324283	00 800-47324289
Netherlands	00 800-47324283	00 800-47324289
Norway	00 800-47324283	00 800-47324289
Poland	00 800-311 12 38	00 800-311 12 38
Spain	00 800-47324283	00 800-47324289
Sweden	00 800-47324283	00 800-47324289
Switzerland	00 800-47324283	00 800-47324289
Turkey	00 800-31 92 91 40	00 800-31 92 91 40
United Kingdom	00 800-47324283	00 800-47324289

FAX Services—All European Countries (toll call)

Warranty Service +31-20-653-3513

Africa/Middle East Support Services

For presales and technical support in Africa and the Middle East, dial our presales and technical support call center at +1-405-324-4714 from 8:00 A.M. to 11:45 A.M. and 1:00 P.M. to 5:00 P.M. (Central Europe time) Monday through Friday. The presales and technical support call center is located in Oklahoma City, USA.

For warranty service in Africa and the Middle East, dial our European call center at +31-20-316-7222 from 8:30 A.M. to 5:00 P.M. (Central Europe time) Monday through Friday, or send a FAX to +31-20-653-3513. The warranty service center is located in Amsterdam, The Netherlands.

Asia/Pacific Support Services

For Asia/Pacific presales and technical support, dial the toll-free number for your specific country. The Asia/Pacific toll-free numbers are available from 6:00 A.M. to 10:45 A.M. and 12:00 P.M. to 6:00 P.M. (Australian Eastern time) Monday through Friday, except as noted. If your country is not listed here, direct dial one of our technical support locations. Warranty service is available from 9:00 A.M. to 6:00 P.M. April through October, and 10:00 P.M. to 7:00 P.M. November through March (Australian Eastern time) Monday through Friday, except as noted.

Call Center	Toll-free	Direct dial	FAX
Australia	1800-14-7201	—	—
China (Chinese) ^{1, 3}	800-810-9668	+86-10-6225-5336	—
Hong Kong	800-90-0474	—	—
Hong Kong (Chinese) ^{1, 3}	001-800-0830-1730	—	—
India ^{2, 3}	1-600-33-1104	—	—
Indonesia	001-803-1-003-2165	—	—
Japan	—	—	+81-3-5462-2978
Malaysia	1-800-80-2335	—	—
New Zealand	0800-443988	—	—
Singapore	800-1101-150	—	+65-6488-7525
Taiwan (Chinese) ^{1, 3}	00-800-0830-1730	—	—
Thailand	001-800-11-0032165	—	—

Warranty Service

Call Center	Toll-free	Direct dial	FAX
Asia/Pacific	—	+65-6485-3595	+65-6485-4860
Australia	1800-12-9277	—	—
India ³	—	+91-44-821-6164	+91-44-827-2461

¹Hours of operation are 8:30 A.M. to 5:30 P.M., Monday through Friday (Australian Western time).

²Hours of operation are 9:00 A.M. to 6:00 P.M., Monday through Saturday.

³Authorized Service Center

Index

A

acoustics 12
Active mode 9
agency certification (regulatory) 13
alternate capacity jumper 17
altitude 10
ambient conditions 3
ambient temperature 6, 10
areal density 1, 5
ATA interface 21
ATA-standard commands 22
Australian C-Tick 14
autodetection 1
average seek time 6

B

BIOS 17
BPI 5
breather filter hole precautions 16
buffer 5
burst 1

C

cable 18
cable select 1
cable-select option 17
cache 1, 5
case temperature 10
CE mark 13
certification 13
Check Power Mode 22
commands 22
compliance 13
conducted noise 8
conducted RF immunity 12
configuring the drive 15
connector pins 21
connectors 18
contact start-stop cycles 13
CSA C22.2 (950) 13
CSEL 17
C-Tick 14
current profile 8
cycles 13

D

data-transfer rates 1
DC power 7
density 5
Device Configuration Freeze Lock 22

Device Configuration Identify 22
Device Configuration Restore 22
Device Configuration Set 22
Device Reset 22
diagnostic software 1, 27
DiscWizard 17
Disk Manager 17
dissipation 7
Download Microcode 22
drive diagnostics 6
drive monitoring 1
drive self-test 1, 27
DST 27

E

electrical fast transient 12
electromagnetic compatibility 13
Electromagnetic Compatibility Directive 13
electromagnetic immunity 12
electrostatic discharge 12
EMC compliance 13
EN 60950 13
enclosures 14
environmental specifications 10
EPRML 1, 5
error-correction algorithms 1
errors 13
European Union 13
Execute Device Diagnostics 22

F

failure prediction 27
FCC verification 14
Features register 27
Flush Cache 22
Flush Cache Extended 22
Format Track 22
formatted capacity 5
frequency 12

G

guaranteed sectors 5

H

handling 15
heads 1
height 6
humidity 10

I

- I/O data-transfer rate 5
- Identify Device 22
- Identify Device command 24
- Idle 7, 22
- Idle and Standby timers 9
- Idle Immediate 22
- Idle mode 9
- Idle mode power 7
- IEC950 13
- Information Technology Equipment 13
- Initialize Device Parameters 22
- interface 5, 21
- interface signals 21
- interference 14
- interleave 5
- internal data-transfer rate OD 5
- ISO document 7779 12

J

- jumper settings 17

K

- Korean RRL 13

L

- LBA mode 5
- length 6
- logical geometry 5

M

- maintenance 13
- master 17
- master/slave 1
- Master/slave configuration 17
- maximum temperature 10
- measurement locations 10
- modes 21
- monitoring 1
- mounting the drive 15, 18

N

- noise 8
- nominal power 3
- nonoperating shock 11
- nonoperating vibration 11
- nonrecoverable read errors 13

O

- operating 7
- operating power and current 7
- operating shock 11
- operating vibration 11
- orientation 18

P

- physical characteristics 6
- pins 21
- PIO 21
- power consumption 7
- power dissipation 7
- power management 9
- power specifications 7
- power-management modes 9
- Power-on to Ready 6
- precautions 18
- preventive maintenance 13
- programmable power management 9

R

- radiated RF immunity 12
- radio and television interference 14
- radio frequency 12
- random track location 7
- Read Buffer 22
- Read DMA 22
- Read DMA Extended 22
- Read DMA without Retries 22
- read errors 13
- Read Log Ext 22
- Read Multiple 1, 22
- Read Multiple Extended 22
- Read Native Max Address 22
- Read Native Max Address Extended 22
- Read Sectors 22
- Read Sectors Extended 22
- Read Sectors Without Retries 22
- Read Verify Sectors 22
- Read Verify Sectors Extended 22
- Read Verify Sectors Without Retries 22
- read/write power and current 7
- Recalibrate 22
- recording and interface technology 5
- recording density 5
- recording heads 1
- recording method 5
- register 27
- relative humidity 10
- reliability 13
- resistance 8
- resistive load 8
- RF 12

S

- S.M.A.R.T. commands 27
- S.M.A.R.T. Disable Operations 23
- S.M.A.R.T. drive monitoring 1
- S.M.A.R.T. Enable/Disable Autosave 23
- S.M.A.R.T. Enable Operations 23
- S.M.A.R.T. Execute Offline 23
- S.M.A.R.T. Read Attribute Thresholds 23
- S.M.A.R.T. Read Data 23
- S.M.A.R.T. Read Log Sector 23
- S.M.A.R.T. Return Status 23
- S.M.A.R.T. Save Attribute Values 23
- S.M.A.R.T. Write Log sector 23
- safety certification 13
- screws 18
- SeaTools 1, 27
- sectors 5
- Security Disable Password 22
- Security Erase Prepare 22
- Security Erase Unit 23
- Security Freeze 23
- Security Set Password 23
- Security Unlock 23
- Seek 23
- seek mode 7
- seek time 6
- Seeking 7
- Service Life 13
- servo electronics 7
- Set Features 23
- Set Features command 27
- Set Max Address 23
- Set Max Address Extended 23
- Set Multiple Mode 23
- shock 11
- signals 21
- single-track seeks 6
- slave 17
- Sleep 7, 23
- Sleep mode 9
- sound 12
- specifications 3
- spindle speed 5
- Spinup 7
- spinup power 7
- Standby 7, 23
- Standby Immediate 23
- Standby mode 7, 9
- Standby to Ready 6
- start/stop times 6
- start-stop cycles 13
- static-discharge precautions 15
- stop times 6
- subassembly 14
- support services 29

- surge immunity 12

T

- technical support services 29
- temperature 10
- temperature gradient 10
- TGMR 1
- timers 9
- track density 5
- track-to-track seek time 6
- TUV North America 13

U

- UL 1950 13
- Ultra ATA/100 18
- Ultra DMA 18

V

- vibration 11
- voltage 8
- voltage dips, interrupts 12
- voltage tolerance 8

W

- weight 6
- wet bulb temperature 10
- width 6
- Write Buffer 23
- Write DMA 23
- Write DMA Extended 23
- Write DMA Without Retries 23
- Write Log Extended 23
- Write Multiple 1, 23
- Write Multiple Extended 23
- Write Sectors 23
- Write Sectors Extended 23
- Write Sectors Without Retries 23



Seagate Technology LLC
920 Disc Drive, Scotts Valley, California 95066-4544, USA
Publication Number: 100323825, Rev. B, Printed in U.S.A.